

TATSUTA

Liquid leakage detector Instruction manual

AD-AS-1WM

Thank you for buying a TATSUTA product.
Read and understand this instruction manual thoroughly before using the product.
Keep this instruction manual carefully so that you can refer to it any time.

! Caution indications

Ignoring the cautions below and handling the product in an incorrect manner may cause death or serious injury as well as fire, electrical shock, or a failure.

! Important points in handling the product

Cautions concerning the environment

- Do not touch the product with a wet hand.
- Do not insert any foreign object into openings.
- Use the product within the specified ratings of the ambient temperature and humidity and storage temperature.
- Keep dry! Do not install the product in a place where the temperature and humidity are high.
- Avoid using the product in a place where there is much dust and dirt.
- Avoid using the product in a place in proximity to vibration, organic gases, and sources of strong electromagnetic induction.
- This product is intended for built-in use; do not install it in a place where people come in contact with it easily.
- Install the detector in a sturdy box in a control panel or the like.

Cautions in using this product

- Perform the installation and wiring as specified in the text of the instruction manual.
- Confirm the rated voltage and power supply voltage of the pieces of equipment before installing them.
- Do not use solvents such as alcohol, benzene, and thinner to clean the product.
- Do not disassemble or modify the pieces of equipment.
- Should the product fail, contact your dealer.
- When disposing of the product, dispose of it as industrial waste.
- When carrying out separation processing for disposal, be careful to prevent injury.
- Do not touch live metal parts such as terminals.
- Do not take out or put in the product with the power supply on.

This device has been delivered to you after strict quality control and inspection. Should this device fail under normal condition of use, we will repair or replace it free of charge within the guarantee period (up to one year after delivery).

* The guarantee is not applicable to failure of the device due to a natural disaster, a fire, unauthorized repair/modification, or dropping/damage after the purchase.

You are kindly requested to ask your dealer for a guarantee document.
When you ask for a guarantee document, you are kindly requested to provide the serial number of the detector to your dealer.

■ Outside dimension drawing for the liquid leakage detector (in mm)

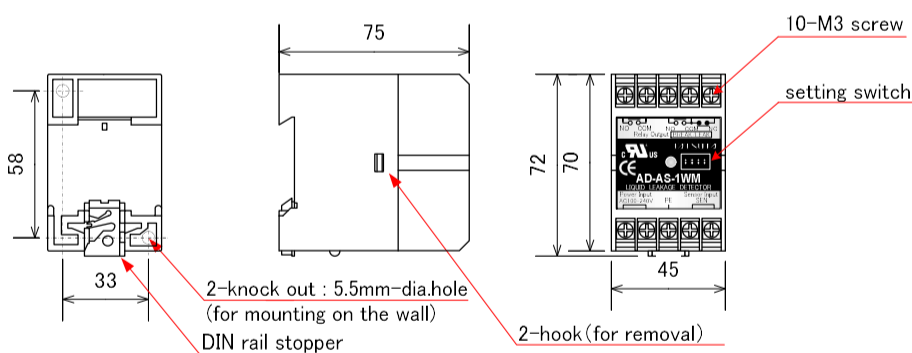

■ Description of the terminal block

Use the specified size of crimped terminals.

- ① Input power supply
100 to 240 VAC, 50/60Hz



- ② Protective earth

To protect from electric shock, PE terminal should be connected to ground.



- ③ Liquid leakage sensor

When wire break detection function is effective, connect wire break detection terminal to the end of the sensor.

When wire break detection terminal is not connected, liquid leakage detector indicate wire break warning.

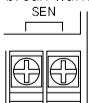

- ④ Relay output

the detector outputs a warning if the detector detects either liquid leakage or wire break.

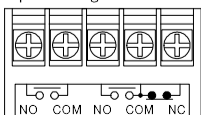

COM-NO is connected in case of warning.
COM-NC is not connected in case of warning.

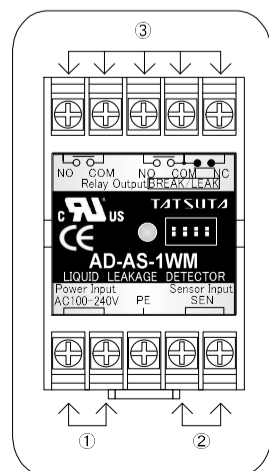
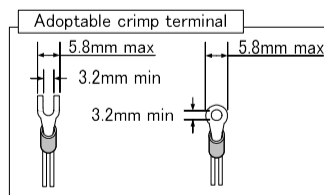

Item	Specification
Power supply	100 to 240VAC, 50/60Hz
Power consumption	2 VA max
Ambient operating temperature	-10°C – 40°C No freezing
Ambient operating humidity	35%RH – 85%RH No condensation
Applied voltage to the sensor	AC 5.3 V (Maximum)
Liquid leakage detection resistance	Four-stage switchover; for more information, refer to "Various Settings." To adjust the setting in the individual range, adjust the settings of the dip switch in the upper part of the detector body.
Wire break detection resistance	30 kilo-ohm min. When you do not use the wire break detection terminal, adjust the settings of the dip switch in the upper part of the detector body.
Indicator lamp	Power-on indication and the liquid leakage and the wire breakage warning in one lamp (one on-off action for liquid leakage and two for wire break)
Contact ratings ※Engineering Data	1c and 1a contact for liquid leakage and wire breakage
	Resistance load Inductive load
Contact ratings ※Approved Standards	Resistance load Inductive load
	AC 125 V 0.4 A (40°C) AC 125 V 0.2 A DC 30 V 2.0 A (40°C) DC 30 V 1.0 A DC 110 V 0.6 A (40°C)
Adaptable sensor	AD-S, AD-RS, AD-HS, AD-FH, AD-FH-S, AD-PA-R, AD-PA-N, FR-AD
Allowable wiring distance (for the sensor section)	Instrumentation cable: 100 m max (conductor diameter: 0.4 mm min) Liquid leakage sensor: 100 m max
Approved standards	UL508 (File No. E480800) EN61010-1 EN61326-1 Industrial electromagnetic environment

■ Various settings

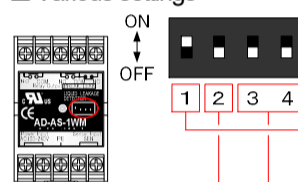

■ SW function (☆ mark means factory settings)

No.1 Wire break detection setting

- OFF : Enable Wire break detection function
- ☆ ON : Disable Wire break detection function
- ※Please switch OFF to enable wire break detection

No.2 Fail safe setting

- ☆OFF : COM-NO is connected in case of warning.
- ON : COM-NO is connected during normal operation.

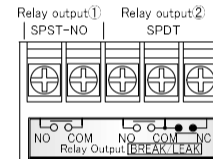

No.3 and 4 Sensitivity setting of liquid leakage

- ON OFF : Low sensitivity 0~2.0kΩ (0~ 1.8kΩ)
 - ☆OFF OFF : Normal sensitivity 0~5.0kΩ (0~ 4.0kΩ)
 - OFF ON : High sensitivity 0~8.0kΩ (0~ 5.7kΩ)
 - ON ON : Super High sensitivity 0~25.0kΩ (0~ 14.0kΩ)
- Accuracy: ±30%.

Values inside the parentheses are those for the case where switch 1 is OFF.

When the AD-PA sensor (point sensor) is used, set sensitivity for super high sensitivity.

■ Cautions in wiring

Example of wiring

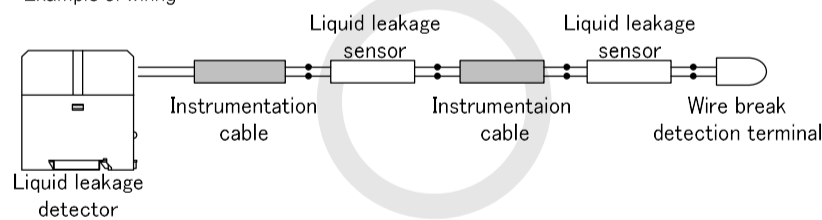

To extend the sensor, connect the instrumentation cable in series.

When the wire break detection terminal is not used, insulate each electrode with vinyl tape or similar material to avoid short-circuiting between the sensor electrodes.

In the following connection, the sensors and the detector do not operate properly.

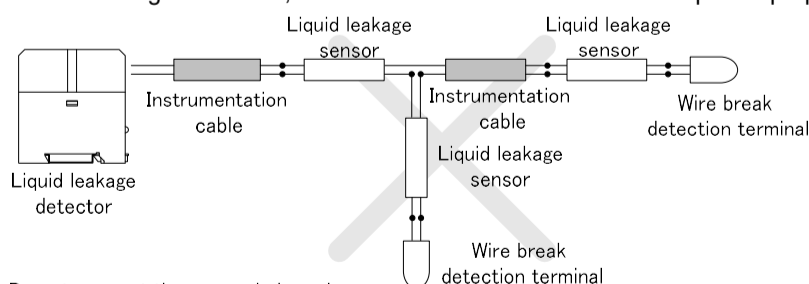

Do not connect the sensor in branches.

Do not use two or more wire break detection terminals.

<<Customer service contacts>>

Tatsuta Electric Wire & Cable Co., Ltd.

● Product Center
3-17, Osadano-cho, Fukuchiyama City, Kyoto Prefecture, 620-0853 Japan
Tel: 0773-45-6500 Fax: 0773-45-6501

● Technical Center
Kunimidai, Kizugawa City, Kyoto Prefecture, 619-0216
Tel: 0774-66-5551 (Switchboard) Fax: 0774-66-5556

● Shanghai Office
Room.409, Shanghai International Trade Centre, 2201 Yan An Road West,
Chang Ning District, Shanghai, China
Tel:+86-21-5058-5177 Fax:+86-21-5058-5199